

DAVIS®

# Veer Price List

Designed by Davis Design Team

Effective March 2, 2020



## VEER Table Series

Specifications .....	2
Images .....	3

### INDOOR TABLES

#### 29" HIGH TABLES

36" Tables .....	4
42" Tables .....	5
48" Tables .....	6
59.5" Table .....	7
72" x 36" Rectangle Table .....	7

#### 42" HIGH TABLES

30" Bar Tables .....	8
36" Bar Tables .....	9

#### 36" HIGH TABLES

36" Tables .....	10
42" Tables .....	11
48" Tables .....	12

### OUTDOOR TABLES

Specifications .....	13
----------------------	----

#### 29" HIGH TABLES

36" Tables .....	14
42" Tables .....	14 - 15
48" Tables .....	15
59.5" Table .....	16
72" x 36" Rectangle Table .....	16

#### 42" HIGH TABLES

30" Bar Tables .....	16 - 17
36" Bar Tables .....	17

For information concerning Condition of Sales, Warranty, Fabric, Finishes, etc., please download the *Conditions of Sales.pdf* on the Davis web site: [www.davisfurniture.com](http://www.davisfurniture.com)

## FEATURES

---

### Base

Stainless Steel column with textured stainless steel over steel plate.  
 Steel column and textured stainless steel base plate may be powder coated. Call factory for pricing.

---

### Glides

All tables standard with grey plastic glides  
 Optional adjustable glides are available – **VR-Glides** Adjustable glides available **\$30** List (set of 5)

---

### Top

Birch plywood with veneer or laminate top surface  
 Multi-plex core with beveled edge has clear coat varnish with laminate tops  
 Painted or stained edges to match laminates are available. Contact factory - upcharge and longer lead time is applicable.  
 Custom sizes may be specified - contact factory for more information  
 Acrylic tops are solid 10mm thick. Offered in white *only*

---

### Edge Detail

#### Veneer Top

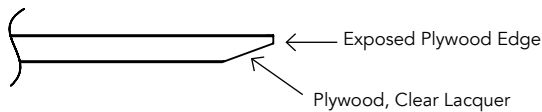

#### Acrylic Top

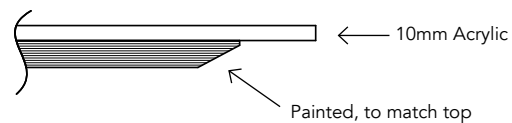

#### Laminate Top

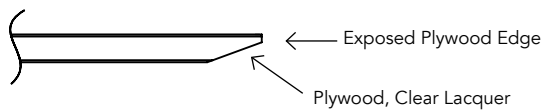

#### Trespa Top

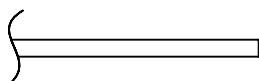

## TABLE OPTIONS



Round Top



Square Top



Round Top /  
Bar Height Table



Square Top /  
Bar Height Table

---

## STAINLESS STEEL DETAIL - for base plate



---

## SOLID SURFACE OPTIONS - for outdoor tables

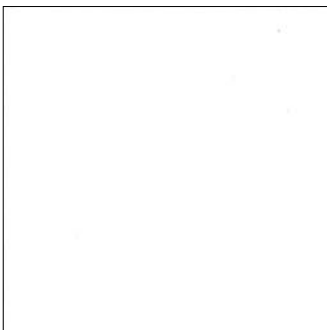

VR-Pure White



VR-Silver Gray



VR-Steel Gray



VR-Black

29" HIGH TABLES

# VEER Table Series

Example: item number **VR-1036-R** + wood suffix **-MM** = **VR-1036-R-MM**

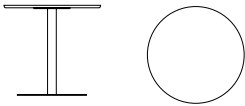
Item	Description	Dimensions Info	inches dia	h	Shipping Weight		
VR-1036-R	36" Round Top	Overall Diameter Acrylic	36	29 29 <sup>2</sup> / <sub>8</sub>	84 lbs.		
		Veneer and Laminate Top Thickness is <sup>3</sup> / <sub>4</sub> " / Column is 3" dia. / Base is 23 <sup>5</sup> / <sub>8</sub> " dia. Acrylic Top Thickness is 1 <sup>1</sup> / <sub>8</sub> "					
List Price		<b>Veneer Top</b>		<b>Laminate Top</b>			
Wood		with Birch Plywood Edge and finished to match top		with Birch Plywood Edge with clear varnish			
Selection		<b>-BB</b>	<b>-MM</b>	<b>-OA</b>	<b>-WW</b>	<b>-LAM</b>	<b>-AY</b>
		Beech	Maple	Oak	Walnut	Laminate	Acrylic
		<b>1508</b>	<b>1508</b>	<b>1508</b>	<b>1508</b>	<b>1328</b>	<b>1658</b>

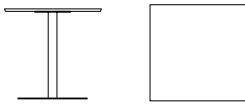
Item	Description	Dimensions Info	w	inches d	h	Shipping Weight	
VR-1036-S	36" Square Top	Overall Acrylic	36	36	29 29 <sup>3</sup> / <sub>8</sub>	90 lbs.	
		Veneer and Laminate Top Thickness is <sup>3</sup> / <sub>4</sub> " / Column is 3" dia. / Base is 23 <sup>5</sup> / <sub>8</sub> " dia. Acrylic Top Thickness is 1 <sup>1</sup> / <sub>8</sub> "					
List Price		<b>Veneer Top</b>		<b>Laminate Top</b>			
Wood		with Birch Plywood Edge and finished to match top		with Birch Plywood Edge with clear varnish			
Selection		<b>-BB</b>	<b>-MM</b>	<b>-OA</b>	<b>-WW</b>	<b>-LAM</b>	<b>-AY</b>
		Beech	Maple	Oak	Walnut	Laminate	Acrylic
		<b>1508</b>	<b>1508</b>	<b>1508</b>	<b>1508</b>	<b>1328</b>	<b>1658</b>

## Required to Specify

Table Finishes :	Beech	<b>-BB</b>	101 Natural Beech 102 Light Beech 103 Medium Beech 104 Dark Beech	Maple	<b>-MM</b>	201 Natural Maple 202 Light Maple	Oak	<b>-OA</b>	301 Natural Oak 302 Medium Oak 303 Grey Oak 304 Brown Oak
	Walnut	<b>-WW</b>	400 Light Walnut 401 Natural Walnut 402 Medium Walnut	Acrylic	<b>-AY</b>	White only			
	Laminate	<b>-LAM</b>	<b>Solid Color Top</b> LAM-Antique White LAM-Black LAM-Designer White LAM-Dove Grey LAM-Fashion Grey LAM-Khaki Brown LAM-Linen LAM-Shadow LAM-Steel LAM-Wallaby	<b>Pattern Laminates</b> LAM-Grey Mesh LAM-Pewter LAM-Steel Mesh			<b>Wood Grain Laminates</b> LAM-Fusion Maple LAM-Monticello Maple LAM-Montana Walnut LAM-River Cherry LAM-Wild Cherry		

## Options *(specify only if preferred)*

Glide : VR-Glides Adjustable glides \$ 30 List (set of 5)

29" HIGH TABLES

# VEER Table Series

Example: item number VR-1042-R + wood suffix -MM = VR-1042-R-MM

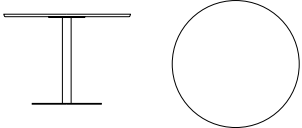
Item	Description	Dimensions Info	inches dia	h	Shipping Weight		
VR-1042-R	42" Round Top	Overall Diameter Acrylic	42	29 29 3/8	92 lbs.		
		Veneer and Laminate Top Thickness is 3/4" / Column is 3" dia. / Base is 23 5/8" dia. Acrylic Top Thickness is 1 1/8"					
List Price		<b>Veneer Top</b>		<b>Laminate Top</b>			
Wood Selection		with Birch Plywood Edge and finished to match top		with Birch Plywood Edge with clear varnish			
		<b>-BB</b>	<b>-MM</b>	<b>-OA</b>	<b>-WW</b>	<b>-LAM</b>	<b>-AY</b>
		Beech	Maple	Oak	Walnut	Laminate	Acrylic
		<b>1654</b>	<b>1654</b>	<b>1654</b>	<b>1654</b>	<b>1434</b>	<b>1842</b>

Item	Description	Dimensions Info	w	inches d	h	Shipping Weight	
VR-1042-S	42" Square Top	Overall Acrylic	42	42	29 29 3/8	100 lbs.	
		Veneer and Laminate Top Thickness is 3/4" / Column is 3" dia. / Base is 23 5/8" dia. Acrylic Top Thickness is 1 1/8"					
List Price		<b>Veneer Top</b>		<b>Laminate Top</b>			
Wood Selection		with Birch Plywood Edge and finished to match top		with Birch Plywood Edge with clear varnish			
		<b>-BB</b>	<b>-MM</b>	<b>-OA</b>	<b>-WW</b>	<b>-LAM</b>	<b>-AY</b>
		Beech	Maple	Oak	Walnut	Laminate	Acrylic
		<b>1654</b>	<b>1654</b>	<b>1654</b>	<b>1654</b>	<b>1434</b>	<b>1842</b>

## Required to Specify

Table Finishes :	Beech	<b>-BB</b>	101 Natural Beech 102 Light Beech 103 Medium Beech 104 Dark Beech	Maple	<b>-MM</b>	201 Natural Maple 202 Light Maple	Oak	<b>-OA</b>	301 Natural Oak 302 Medium Oak 303 Grey Oak 304 Brown Oak
	Walnut	<b>-WW</b>	400 Light Walnut 401 Natural Walnut 402 Medium Walnut	Acrylic	<b>-AY</b>	White only			
	Laminate	<b>-LAM</b>	<b>Solid Color Top</b> LAM-Antique White LAM-Black LAM-Designer White LAM-Dove Grey LAM-Fashion Grey LAM-Khaki Brown LAM-Linen LAM-Shadow LAM-Steel LAM-Wallaby	<b>Pattern Laminates</b> LAM-Grey Mesh LAM-Pewter LAM-Steel Mesh			<b>Wood Grain Laminates</b> LAM-Fusion Maple LAM-Monticello Maple LAM-Montana Walnut LAM-River Cherry LAM-Wild Cherry		

## Options *(specify only if preferred)*

Glide : VR-Glides Adjustable glides \$30 List (set of 5)

29" HIGH TABLES

# VEER Table Series

Example: item number **VR-1048-S** + wood suffix **-BB** = **VR-1048-S-BB**

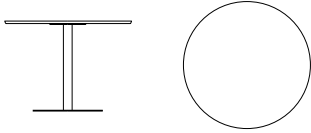
Item	Description	Dimensions Info	inches dia	h	Shipping Weight		
VR-1048-R	48" Round Top	Overall Diameter Acrylic	48	29 29 3/8	101 lbs.		
		Veneer and Laminate Top Thickness is 3/4" / Column is 3" dia. / Base is 23 5/8" dia. Acrylic Top Thickness is 1 1/8"					
List Price		<b>Veneer Top</b>		<b>Laminate Top</b>			
Wood Selection		with Birch Plywood Edge and finished to match top		with Birch Plywood Edge with clear varnish			
		<b>-BB</b>	<b>-MM</b>	<b>-OA</b>	<b>-WW</b>	<b>-LAM</b>	<b>-AY</b>
		Beech	Maple	Oak	Walnut	Laminate	Acrylic
		<b>1827</b>	<b>1827</b>	<b>1827</b>	<b>1827</b>	<b>1549</b>	<b>1997</b>

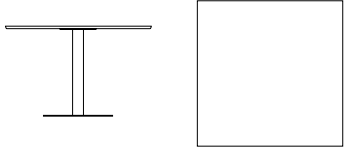
Item	Description	Dimensions Info	w	d	h	Shipping Weight	
VR-1048-S	48" Square Top	Outside Acrylic	48	48	29 29 3/8	112 lbs.	
		Veneer and Laminate Top Thickness is 3/4" / Column is 3" dia. / Base is 23 5/8" dia. Acrylic Top Thickness is 1 1/8"					
List Price		<b>Veneer Top</b>		<b>Laminate Top</b>			
Wood Selection		with Birch Plywood Edge and finished to match top		with Birch Plywood Edge with clear varnish			
		<b>-BB</b>	<b>-MM</b>	<b>-OA</b>	<b>-WW</b>	<b>-LAM</b>	<b>-AY</b>
		Beech	Maple	Oak	Walnut	Laminate	Acrylic
		<b>1827</b>	<b>1827</b>	<b>1827</b>	<b>1827</b>	<b>1549</b>	<b>1997</b>

## Required to Specify

Table Finishes :	Beech	<b>-BB</b>	101 Natural Beech 102 Light Beech 103 Medium Beech 104 Dark Beech	Maple	<b>-MM</b>	201 Natural Maple 202 Light Maple	Oak	<b>-OA</b>	301 Natural Oak 302 Medium Oak 303 Grey Oak 304 Brown Oak
	Walnut	<b>-WW</b>	400 Light Walnut 401 Natural Walnut 402 Medium Walnut	Acrylic	<b>-AY</b>	White only			
	Laminate	<b>-LAM</b>	<b>Solid Color Top</b> LAM-Antique White LAM-Black LAM-Designer White LAM-Dove Grey LAM-Fashion Grey LAM-Khaki Brown LAM-Linen LAM-Shadow LAM-Steel LAM-Wallaby			<b>Pattern Laminates</b> LAM-Grey Mesh LAM-Pewter LAM-Steel Mesh			<b>Wood Grain Laminates</b> LAM-Fusion Maple LAM-Monticello Maple LAM-Montana Walnut LAM-River Cherry LAM-Wild Cherry

## Options (specify only if preferred)

Glide : **VR-Glides** Adjustable glides \$30 List (set of 5)

29" HIGH TABLES

# VEER Table Series

Example: item number **VR-1060-R** + wood suffix **-MM** = **VR-1060-R-MM**

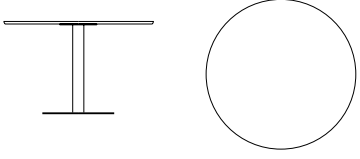
Item	Description	Dimensions Info	inches dia	h	Shipping Weight	
VR-1060-R	60" Round Top	Overall Diameter Acrylic	59 1/2	29 29 3/8	181 lbs.	
		Top Thickness is 3/4" / Column is 5" dia. / Base is 31 1/2" dia. Acrylic Top Thickness is 1 1/8"				
List Price		<b>Veneer Top</b>		<b>Laminate Top</b>		
Wood Selection		with Birch Plywood Edge and finished to match top		with Birch Plywood Edge with clear varnish		
		<b>-BB</b>	<b>-MM</b>	<b>-OA</b>	<b>-WW</b>	<b>-LAM</b>
		Beech	Maple	Oak	Walnut	Laminate
		<b>2678</b>	<b>2678</b>	<b>2678</b>	<b>2678</b>	<b>2274</b>

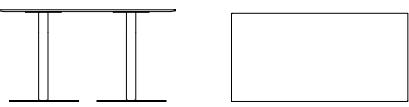
Item	Description	Dimensions Info	w	d	h	Shipping Weight	
VR-1272-RE	72" x 36" Rectangle Table with two pedestals	Outside Acrylic	72	36	29 29 3/8	178 lbs.	
		Top Thickness is 3/4" / Column is 3" dia. / Bases are 23 5/8" dia. Acrylic Top Thickness is 1 1/8"					
List Price		<b>Veneer Top</b>		<b>Laminate Top</b>			
Wood Selection		with Birch Plywood Edge and finished to match top		with Birch Plywood Edge with clear varnish			
		<b>-BB</b>	<b>-MM</b>	<b>-OA</b>	<b>-WW</b>	<b>-LAM</b>	<b>-AY</b>
		Beech	Maple	Oak	Walnut	Laminate	Acrylic
		<b>2817</b>	<b>2817</b>	<b>2817</b>	<b>2817</b>	<b>2507</b>	<b>3062</b>

## Required to Specify

Table Finishes :	Beech	<b>-BB</b>	101 Natural Beech 102 Light Beech 103 Medium Beech 104 Dark Beech	Maple	<b>-MM</b>	201 Natural Maple 202 Light Maple	Oak	<b>-OA</b>	301 Natural Oak 302 Medium Oak 303 Grey Oak 304 Brown Oak
	Walnut	<b>-WW</b>	400 Light Walnut 401 Natural Walnut 402 Medium Walnut	Acrylic	<b>-AY</b>	White only - not available on VR-1060-R			
	Laminate	<b>-LAM</b>	<b>Solid Color Top</b> LAM-Antique White LAM-Black LAM-Designer White LAM-Dove Grey LAM-Fashion Grey LAM-Khaki Brown LAM-Linen LAM-Shadow LAM-Steel LAM-Wallaby	<b>Pattern Laminates</b> LAM-Grey Mesh LAM-Pewter LAM-Steel Mesh		<b>Wood Grain Laminates</b> LAM-Fusion Maple LAM-Monticello Maple LAM-Montana Walnut LAM-River Cherry LAM-Wild Cherry			

## Options (specify only if preferred)

Glide : VR-Glides Adjustable glides \$ 30 List (set of 5)



42" HIGH TABLES

# VEER Table Series

Example: item number **VR-1130-R** + wood suffix **-MM** = **VR-1130-R-MM**

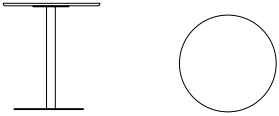
Item	Description	Dimensions Info	inches dia	h	Shipping Weight		
VR-1130-R	30" Round Bar Top	Overall Diameter Acrylic	30	42 42 <sup>3</sup> / <sub>8</sub>	80 lbs.		
		Top Thickness is <sup>3</sup> / <sub>4</sub> " / Column is 3" dia. / Base is 23 <sup>5</sup> / <sub>8</sub> " dia. Acrylic Top Thickness is 1 <sup>1</sup> / <sub>8</sub> "					
List Price		<b>Veneer Top</b>		<b>Laminate Top</b>			
Wood Selection		with Birch Plywood Edge and finished to match top		with Birch Plywood Edge with clear varnish			
		<b>-BB</b>	<b>-MM</b>	<b>-OA</b>	<b>-WW</b>	<b>-LAM</b>	<b>-AY</b>
		Beech	Maple	Oak	Walnut	Laminate	Acrylic
		<b>1428</b>	<b>1428</b>	<b>1428</b>	<b>1428</b>	<b>1295</b>	<b>1540</b>

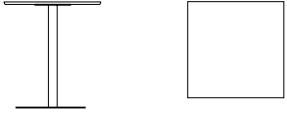
Item	Description	Dimensions Info	w	inches d	h	Shipping Weight	
VR-1130-S	30" Square Bar Top	Outside Acrylic	30	30	42 42 <sup>3</sup> / <sub>8</sub>	84 lbs.	
		Top Thickness is <sup>3</sup> / <sub>4</sub> " / Column is 3" dia. / Base is 23 <sup>5</sup> / <sub>8</sub> " dia. Acrylic Top Thickness is 1 <sup>1</sup> / <sub>8</sub> "					
List Price		<b>Veneer Top</b>			<b>Laminate Top</b>		
Wood Selection		with Birch Plywood Edge and finished to match top			with Birch Plywood Edge with clear varnish		
		<b>-BB</b>	<b>-MM</b>	<b>-OA</b>	<b>-WW</b>	<b>-LAM</b>	<b>-AY</b>
		Beech	Maple	Oak	Walnut	Laminate	Acrylic
		<b>1428</b>	<b>1428</b>	<b>1428</b>	<b>1428</b>	<b>1295</b>	<b>1540</b>

## Required to Specify

Table Finishes :	Beech	<b>-BB</b>	101 Natural Beech 102 Light Beech 103 Medium Beech 104 Dark Beech	Maple	<b>-MM</b>	201 Natural Maple 202 Light Maple	Oak	<b>-OA</b>	301 Natural Oak 302 Medium Oak 303 Grey Oak 304 Brown Oak
	Walnut	<b>-WW</b>	400 Light Walnut 401 Natural Walnut 402 Medium Walnut	Acrylic	<b>-AY</b>	White only			
	Laminate	<b>-LAM</b>	<b>Solid Color Top</b> LAM-Antique White LAM-Black LAM-Designer White LAM-Dove Grey LAM-Fashion Grey LAM-Khaki Brown LAM-Linen LAM-Shadow LAM-Steel LAM-Wallaby	<b>Pattern Laminates</b> LAM-Grey Mesh LAM-Pewter LAM-Steel Mesh			<b>Wood Grain Laminates</b> LAM-Fusion Maple LAM-Monticello Maple LAM-Montana Walnut LAM-River Cherry LAM-Wild Cherry		

## Options *(specify only if preferred)*

Glide : VR-Glides Adjustable glides \$30 List (set of 5)

42" HIGH TABLES

# VEER Table Series

Example: item number VR-1136-S + wood suffix -WW = VR-1136-S-WW

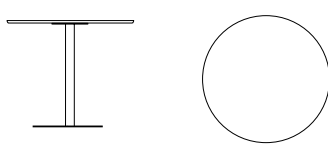
Item	Description	Dimensions Info	inches dia	h	Shipping Weight		
VR-1136-R	36" Round Bar Top	Overall Acrylic	36	42 42 <sup>3</sup> / <sub>8</sub>	87 lbs.		
		Top Thickness is <sup>3</sup> / <sub>4</sub> " / Column is 3" dia. / Base is 23 <sup>5</sup> / <sub>8</sub> " dia. Acrylic Top Thickness is 1 <sup>1</sup> / <sub>8</sub> "					
List Price Wood Selection		<b>Veneer Top</b>				<b>Laminate Top</b>	
		with Birch Plywood Edge and finished to match top				with Birch Plywood Edge with clear varnish	
		<b>-BB</b>	<b>-MM</b>	<b>-OA</b>	<b>-WW</b>	<b>-LAM</b>	<b>-AY</b>
		Beech	Maple	Oak	Walnut	Laminate	Acrylic
		<b>1558</b>	<b>1558</b>	<b>1558</b>	<b>1558</b>	<b>1385</b>	<b>1699</b>

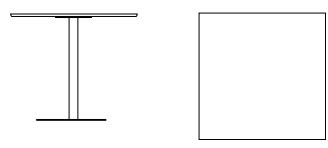
Item	Description	Dimensions Info	w	inches d	h	Shipping Weight	
VR-1136-S	36" Square Bar Top	Outside Acrylic	36	36	42 42 <sup>3</sup> / <sub>8</sub>	93 lbs.	
		Top Thickness is <sup>3</sup> / <sub>4</sub> " / Column is 3" dia. / Base is 23 <sup>5</sup> / <sub>8</sub> " dia. Acrylic Top Thickness is 1 <sup>1</sup> / <sub>8</sub> "					
List Price Wood Selection		<b>Veneer Top</b>				<b>Laminate Top</b>	
		with Birch Plywood Edge and finished to match top				with Birch Plywood Edge with clear varnish	
		<b>-BB</b>	<b>-MM</b>	<b>-OA</b>	<b>-WW</b>	<b>-LAM</b>	<b>-AY</b>
		Beech	Maple	Oak	Walnut	Laminate	Acrylic
		<b>1558</b>	<b>1558</b>	<b>1558</b>	<b>1558</b>	<b>1385</b>	<b>1699</b>

## Required to Specify

Table Finishes :	Beech	<b>-BB</b>	101 Natural Beech 102 Light Beech 103 Medium Beech 104 Dark Beech	Maple	<b>-MM</b>	201 Natural Maple 202 Light Maple	Oak	<b>-OA</b>	301 Natural Oak 302 Medium Oak 303 Grey Oak 304 Brown Oak
	Walnut	<b>-WW</b>	400 Light Walnut 401 Natural Walnut 402 Medium Walnut	Acrylic	<b>-AY</b>	White only			
	Laminate	<b>-LAM</b>	<i>Solid Color Top</i> LAM-Antique White LAM-Black LAM-Designer White LAM-Dove Grey LAM-Fashion Grey LAM-Khaki Brown LAM-Linen LAM-Shadow LAM-Steel LAM-Wallaby			<i>Pattern Laminates</i> LAM-Grey Mesh LAM-Pewter LAM-Steel Mesh			<i>Wood Grain Laminates</i> LAM-Fusion Maple LAM-Monticello Maple LAM-Montana Walnut LAM-River Cherry LAM-Wild Cherry

## Options (specify only if preferred)

Glide : VR-Glides Adjustable glides \$ 30List (set of 5)

36" HIGH TABLES

# VEER Table Series

Example: item number VR-1236-R + wood suffix -MM = VR-1236-R-MM

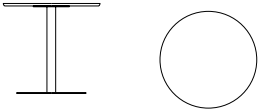
Item	Description	Dimensions Info	inches dia	h	Shipping Weight		
VR-1236-R	36" Round Top	Overall Diameter	36	36	84 lbs.		
		Top Thickness is 3/4" / Column is 3" dia. / Base is 23 5/8" dia. Acrylic Top Thickness is 1 1/8"					
List Price		<b>Veneer Top</b>		<b>Laminate Top</b>			
Wood Selection		with Birch Plywood Edge and finished to match top		with Birch Plywood Edge with clear varnish			
		-BB	-MM	-OA	-WW	-LAM	-AY
		Beech	Maple	Oak	Walnut	Laminate	Acrylic
		1536	1536	1536	1536	1358	1677

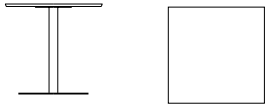
Item	Description	Dimensions Info	w	inches d	h	Shipping Weight	
VR-1236-S	36" Square Top	Overall	36	36	36	90 lbs.	
		Top Thickness is 3/4" / Column is 3" dia. / Base is 23 5/8" dia. Acrylic Top Thickness is 1 1/8"					
List Price		<b>Veneer Top</b>		<b>Laminate Top</b>			
Wood Selection		with Birch Plywood Edge and finished to match top		with Birch Plywood Edge with clear varnish			
		-BB	-MM	-OA	-WW	-LAM	-AY
		Beech	Maple	Oak	Walnut	Laminate	Acrylic
		1536	1536	1536	1536	1358	1677

## Required to Specify

Table Finishes :	Beech	-BB	101 Natural Beech 102 Light Beech 103 Medium Beech 104 Dark Beech	Maple	-MM	201 Natural Maple 202 Light Maple	Oak	-OA	301 Natural Oak 302 Medium Oak 303 Grey Oak 304 Brown Oak
	Walnut	-WW	400 Light Walnut 401 Natural Walnut 402 Medium Walnut	Acrylic	-AY	White only			
	Laminate	-LAM	<b>Solid Color Top</b> LAM-Antique White LAM-Black LAM-Designer White LAM-Dove Grey LAM-Fashion Grey LAM-Khaki Brown LAM-Linen LAM-Shadow LAM-Steel LAM-Wallaby	<b>Pattern Laminates</b> LAM-Grey Mesh LAM-Pewter LAM-Steel Mesh			<b>Wood Grain Laminates</b> LAM-Fusion Maple LAM-Monticello Maple LAM-Montana Walnut LAM-River Cherry LAM-Wild Cherry		

## Options *(specify only if preferred)*

Glide : VR-Glides Adjustable glides \$30 List (set of 5)

Example: item number VR-1242-R + wood suffix -MM = VR-1242-R-MM

Item	Description	Dimensions Info	inches dia	h	Shipping Weight
VR-1242-R	42" Round Top	Overall Diameter	42	36	92 lbs.

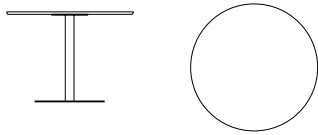

Top Thickness is 3/4" / Column is 3" dia. / Base is 23 5/8" dia.

List Price Wood Selection	Veneer Top with Birch Plywood Edge and finished to match top				Laminate Top with Birch Plywood Edge with clear varnish	
	-BB Beech	-MM Maple	-OA Oak	-WW Walnut	-LAM Laminate	-AY Acrylic
	1682	1682	1682	1682	1462	1892

Item	Description	Dimensions Info	w	d	h	Shipping Weight
VR-1242-S	42" Square Top	Overall	42	42	36	100 lbs.

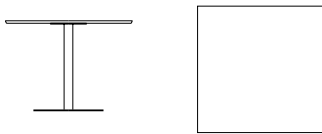

Top Thickness is 3/4" / Column is 3" dia. / Base is 23 5/8" dia.

List Price Wood Selection	Veneer Top with Birch Plywood Edge and finished to match top				Laminate Top with Birch Plywood Edge with clear varnish	
	-BB Beech	-MM Maple	-OA Oak	-WW Walnut	-LAM Laminate	-AY Acrylic
	1682	1682	1682	1682	1462	1892

## Required to Specify

Table Finishes :	Beech	-BB	101 Natural Beech 102 Light Beech 103 Medium Beech 104 Dark Beech	Maple	-MM	201 Natural Maple 202 Light Maple	Oak	-OA	301 Natural Oak 302 Medium Oak 303 Grey Oak 304 Brown Oak
	Walnut	-WW	400 Light Walnut 401 Natural Walnut 402 Medium Walnut	Acrylic	-AY	White only			
	Laminate	-LAM	<b>Solid Color Top</b> LAM-Antique White LAM-Black LAM-Designer White LAM-Dove Grey LAM-Fashion Grey LAM-Khaki Brown LAM-Linen LAM-Shadow LAM-Steel LAM-Wallaby	<b>Pattern Laminates</b> LAM-Grey Mesh LAM-Pewter LAM-Steel Mesh		<b>Wood Grain Laminates</b> LAM-Fusion Maple LAM-Monticello Maple LAM-Montana Walnut LAM-River Cherry LAM-Wild Cherry			

## Options *(specify only if preferred)*

Glide : VR-Glides Adjustable glides \$ 30 List (set of 5)

36" HIGH TABLES

# VEER Table Series

Example: item number VR-1248-R + wood suffix -BB = VR-1248-R-BB

Item	Description	Dimensions Info	inches dia	h	Shipping Weight
VR-1248-R	48" Round Top	Overall Diameter	48	36	101 lbs.

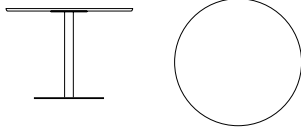

Top Thickness is 3/4" / Column is 3" dia. / Base is 23 5/8" dia.

List Price Wood Selection	Veneer Top with Birch Plywood Edge and finished to match top				Laminate Top with Birch Plywood Edge with clear varnish	
	-BB Beech	-MM Maple	-OA Oak	-WW Walnut	-LAM Laminate	-AY Acrylic
	1853	1853	1853	1853	1575	2048

Item	Description	Dimensions Info	w	inches d	h	Shipping Weight
VR-1248-S	48" Square Top	Outside	48	48	36	112 lbs.

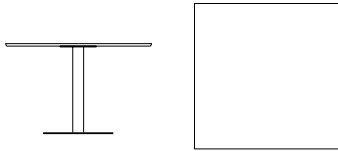

Top Thickness is 3/4" / Column is 3" dia. / Base is 23 5/8" dia.

List Price Wood Selection	Veneer Top with Birch Plywood Edge and finished to match top				Laminate Top with Birch Plywood Edge with clear varnish	
	-BB Beech	-MM Maple	-OA Oak	-WW Walnut	-LAM Laminate	-AY Acrylic
	1853	1853	1853	1853	1575	2048

## Required to Specify

Table Finishes :	Beech	-BB	101 Natural Beech 102 Light Beech 103 Medium Beech 104 Dark Beech	Maple	-MM	201 Natural Maple 202 Light Maple	Oak	-OA	301 Natural Oak 302 Medium Oak 303 Grey Oak 304 Brown Oak
	Walnut	-WW	400 Light Walnut 401 Natural Walnut 402 Medium Walnut	Acrylic	-AY	White only			
	Laminate	-LAM	<b>Solid Color Top</b> LAM-Antique White LAM-Black LAM-Designer White LAM-Dove Grey LAM-Fashion Grey LAM-Khaki Brown LAM-Linen LAM-Shadow LAM-Steel LAM-Wallaby	<b>Pattern Laminates</b> LAM-Grey Mesh LAM-Pewter LAM-Steel Mesh		<b>Wood Grain Laminates</b> LAM-Fusion Maple LAM-Monticello Maple LAM-Montana Walnut LAM-River Cherry LAM-Wild Cherry			

## Options *(specify only if preferred)*

Glide : VR-Glides Adjustable glides \$30 List (set of 5)

## FEATURES

---

### Top

13mm thick Trespa Meteon. Four colors available, **VR-Black**, **VR-Pure White**, **VR-Silver Grey**, **VR-Steel Grey**  
Black solid core edge  
Custom sizes may be specified - contact factory for more information

---

### Base

Stainless Steel column with textured stainless steel over powder coated steel plate.

---

### Glides

Adjustable glides come standard with every outdoor table.

---

### Special Solid Surface

Additional colors available on request - contact factory for pricing



Example: item number VR-2036-R + material suffix -TM = VR-2036-R-TM

Item	Description	Dimensions Info	inches dia	h	Shipping Weight
VR-2036-R	36" Round Top Outdoor Table	Overall	36	29	87 lbs

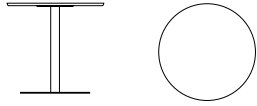

Top Thickness is 1/2" / Column is 3" dia. / Base is 23 5/8" dia.

**-TM**

List Price Trespa® Meteon

**2023**

Item	Description	Dimensions Info	w	inches d	h	Shipping Weight
VR-2036-S	36" Square Top Outdoor Table	Outside	36	36	29	94 lbs

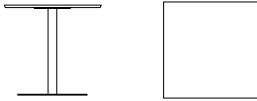

Top Thickness is 1/2" / Column is 3" dia. / Base is 23 5/8" dia.

**-TM**

List Price Trespa® Meteon

**2023**

Item	Description	Dimensions Info	inches dia	h	Shipping Weight
VR-2042-R	42" Round Top Outdoor Table	Outside	42	29	97 lbs

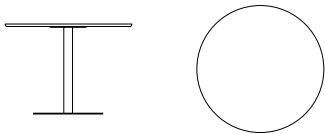

Top Thickness is 1/2" / Column is 3" dia. / Base is 23 5/8" dia.

**-TM**

List Price Trespa® Meteon

**2430**

## Required to Specify

- Top Finishes : VR-Black  
 VR-Pure White  
 VR-Silver Grey  
 VR-Steel Grey

OUTDOOR TABLES

# VEER Table Series

Example: item number **VR-2042-S** + material suffix **-TM** = **VR-2042-S-TM**

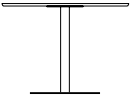
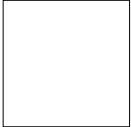
Item	Description	Dimensions Info	inches			Shipping Weight
			w	d	h	
VR-2042-S	42" Square Top Outdoor Table	Overall	42	42	29	106 lbs
 		Top Thickness is 1/2" / Column is 3" dia. / Base is 23 5/8" dia.				
List Price		-TM Trespa® Meteor				
<b>2430</b>						

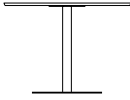
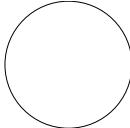
Item	Description	Dimensions Info	inches		Shipping Weight
			dia	h	
VR-2048-R	48" Round Top Outdoor Table	Overall Diameter	48	29	108 lbs
 		Top Thickness is 1/2" / Column is 3" dia. / Base is 23 5/8" dia.			
List Price		-TM Trespa® Meteor			
<b>2440</b>					

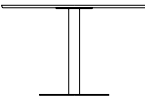
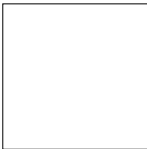
Item	Description	Dimensions Info	inches			Shipping Weight
			w	d	h	
VR-2048-S	48" Square Top Outdoor Table	Outside	48	48	29	120 lbs
 		Top Thickness is 1/2" / Column is 3" dia. / Base is 23 5/8" dia.				
List Price		-TM Trespa® Meteor				
<b>2440</b>						

## Required to Specify

- Top Finishes :
- VR-Black
  - VR-Pure White
  - VR-Silver Grey
  - VR-Steel Grey



OUTDOOR TABLES

# VEER Table Series

Example: item number VR-2060-R + material suffix -TM = VR-2060-R-TM

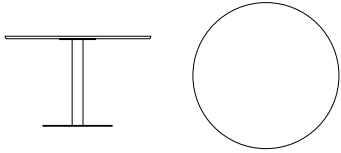
Item	Description	Dimensions Info	inches dia	h	Shipping Weight
VR-2060-R	59.5" Round Top Outdoor Table	Overall	59.5	29	191 lbs
		Top Thickness is 1/2" / Column is 5" dia. / Base is 31 1/2" dia.			
List Price		<b>-TM</b> Trespa® Meeon <b>2954</b>			

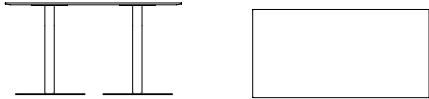
Item	Description	Dimensions Info	w	inches d	h	Shipping Weight
VR-2272-RE	72" x 36" Rectangle Table with two pedestals Outdoor Table	Overall	72	36	29	188 lbs
		Top Thickness is 1/2" / Column is 3" dia. / Bases are 23 5/8" dia.				
List Price		<b>-TM</b> Trespa® Meeon <b>3955</b>				

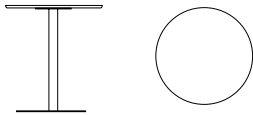
Item	Description	Dimensions Info	inches dia	h	Shipping Weight
VR-2130-R	30" Round Bar Top Outdoor Table	Overall Diameter	30	42	82 lbs
		Top Thickness is 1/2" / Column is 3" dia. / Base is 23 5/8" dia.			
List Price		<b>-TM</b> Trespa® Meeon <b>1667</b>			

## Required to Specify

- Top Finishes : VR-Black  
 VR-Pure White  
 VR-Silver Grey  
 VR-Steel Grey

OUTDOOR TABLES

# VEER Table Series

Example: item number VR-2130-S + material suffix -TM = VR-2130-S-TM

Item	Description	Dimensions Info	inches			Shipping Weight
			w	d	h	
VR-2130-S	30" Square Bar Top Outdoor Table	Outside	30	30	42	87 lbs

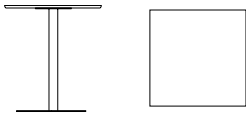

Top Thickness is 1/2" / Column is 3" dia. / Base is 23 5/8" dia.

-TM

List Price Trespa® Meteon

1667

Item	Description	Dimensions Info	inches		Shipping Weight
			dia	h	
VR-2136-R	36" Round Bar Top Outdoor Table	Overall	36	42	90 lbs

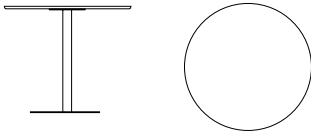

Top Thickness is 1/2" / Column is 3" dia. / Base is 23 5/8" dia.

-TM

List Price Trespa® Meteon

2076

Item	Description	Dimensions Info	inches			Shipping Weight
			w	d	h	
VR-2136-S	36" Square Bar Top Outdoor Table	Outside	36	36	42	97 lbs

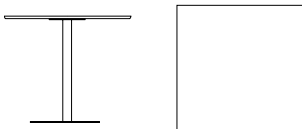

Top Thickness is 1/2" / Column is 3" dia. / Base is 23 5/8" dia.

-TM

List Price Trespa® Meteon

2076

## Required to Specify

- Top Finishes : VR-Black  
 VR-Pure White  
 VR-Silver Grey  
 VR-Steel Grey